

heatmiser®



Model: Slimline V3

## Model: Slimline V3





# Table of Contents

|   |          |                                 |              |
|---|----------|---------------------------------|--------------|
| Product Image                           | 1        | Adjusting the Optional Features | 23           |
| Table of Contents                       | 2        | Optional Features - Table       | 24           |
| What is a Programmable Room Thermostat? | 3-4      | Re-calibrating the Thermostat   | 25           |
| Installation Procedure                  | 5-6      | Error Codes                     | 26           |
| Mode Select/Factory Reset               | 7        | <b>Mode 2 - Time Clock</b>      | <b>27</b>    |
| <b>Mode 1 - Thermostat</b>              | <b>8</b> | LCD Display                     | 28-29        |
| LCD Display                             | 9-10     | Setting the Clock               | 30           |
| Setting the Clock                       | 11       | Locking the Time Clock          | 31           |
| Temperature Display                     | 12       | Setting the Switching Times     | 32           |
| Comfort Levels                          | 13-14    | Countdown Mode                  | 33           |
| Locking the Thermostat                  | 15       | Timer Override                  | 34           |
| Temperature Control                     | 16       | Holiday                         | 35           |
| Temperature Hold                        | 17       | Optional Features Explained     | 36           |
| Holiday                                 | 18       | Optional Features - Table       | 36           |
| Frost Protection                        | 19       | Adjusting the Optional Features | 37           |
| Heating On/Off                          | 20       | <b>Wiring Diagrams</b>          | <b>39-41</b> |
| Option Features Explained               | 21-22    |                                 |              |

## What is a Programmable Room Thermostat?

A programmable room thermostat is both a programmer and a room thermostat.

The programmer allows you to set “On” and “Off” periods to suit your own lifestyle. The room thermostat works by sensing the air temperature, switching on the heating when the air temperature falls below the thermostat setting, and switching it off once this set temperature has been reached.

So a programmable room thermostat lets you choose what times you want the heating to be on, and what temperature it should reach while it is on. It will allow you to select different temperatures in your home at different times of the day (and days of the week) to meet your particular needs and preferences.

Setting a programmable room thermostat to a higher temperature will not make the room heat up any faster. How quickly the room heats up depends on the design & size of the heating system.

Similarly reducing the temperature setting does not affect how quickly the room cools down. Setting a programmable room thermostat to a lower temperature will result in the room being controlled at a lower temperature, and saves energy.

The way to set and use your programmable room thermostat is to find the lowest temperature settings that you are comfortable with at the different times you have chosen, and then leave it alone to do its job.

The best way to do this is to set the room thermostat to a low temperature – say 18°C, and then turn it up by 1°C each day until you are comfortable with the temperature. You won't have to adjust the thermostat further. Any adjustment above this setting will waste energy and cost you more money.

If your heating system is a boiler with radiators, there will usually be only one programmable room thermostat to control the whole house. But you can have different temperatures in individual rooms by installing thermostatic radiator valves (TRVs) on individual radiators.

If you don't have TRVs, you should choose a temperature that is reasonable for the whole house. If you do have TRVs, you can choose a slightly higher setting to make sure that even the coldest room is comfortable, then prevent any overheating in other rooms by adjusting the TRVs.

You are able to temporarily adjust the heating program by overriding or using the temperature hold feature. These features are explained further on pages 16 and 17 of this manual.

Programmable room thermostats need a free flow of air to sense the temperature, so they must not be covered by curtains or blocked by furniture. Nearby electric fires, televisions, wall or table lamps may also prevent the thermostat from working properly.



## Installation Procedure



### Do

Mount the thermostat at eye level.

Read the instructions fully so you get the best from our product.



### Don't

Do not install near to a direct heat source as this will affect functionality.

Do not push hard on the LCD screen as this may cause irreparable damage.

*This Slimline Series thermostat is designed to be flush mounted and requires a back box of 35mm (minimum depth) to be sunk into the wall prior to installation.*

### Step 1

Carefully separate the front half of the thermostat from the back plate by placing a small flat head terminal driver into the slots on the bottom face of the thermostat.

### Step 2

Place the thermostat front somewhere safe.

Terminate the thermostat as shown in the diagrams on pages 39-41 of this booklet.

### Step 3

Screw the thermostat back plate securely into the back box.

### Step 4

Clip the front of the thermostat back onto the thermostat back plate.

1



2

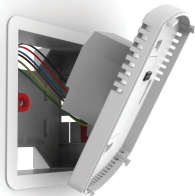

3

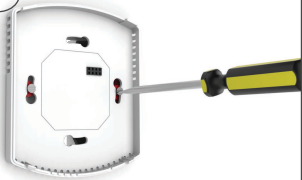

4







## Mode Select/Factory Reset



Slimline can either be used as a thermostat or a time clock. Thermostat mode is the default setting.

To change between thermostat & time clock modes, follow these steps.

- Hold down the 'Power' button to turn off the display..... 
- Press and hold the Power and Up keys together until the LCD powers up.  
All of the icons will be displayed on screen momentarily ..... 

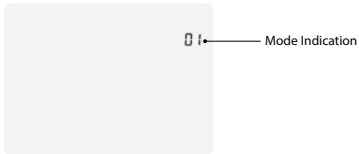
*The device will factory reset then provide 2 selectable mode options.*



- Tap the Up/Down keys to select the desired mode ..... 
  - Mode 01 = Programmable Thermostat
  - Mode 02 = Time Clock
- Press A to confirm settings..... 
- Tap the 'Power' button to turn the display on..... 



1

## Mode 1 - Thermostat



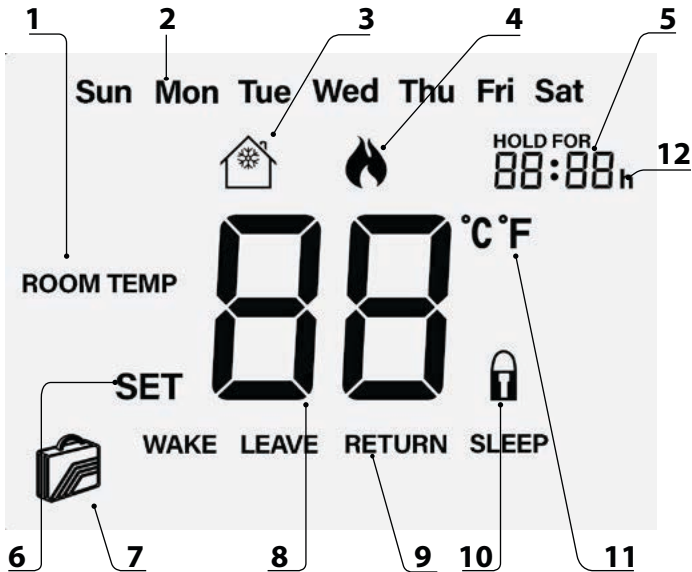







## LCD Display

1. Room Temp - Indicates the current temperature sensor mode.
2. Day Indicator - Displays the current day.
3. Frost Icon - Displayed when the thermostat is in frost protection mode.
4. Flame Icon - Displayed when the thermostat is calling for heat, the flame icon will flash when the optimum start function is in operation.
5. Temperature Hold - When a Temp Hold is active, HOLD FOR and the remaining time period is displayed.
6. Set - Indicates when changes are being made to programs or temperature set points.
7. Holiday Indicator - Displayed when the thermostat is in holiday mode.
8. Current Temp - Indicates the current sensor temperature.
9. Program Cycle Indicator - Displayed during programming only to show which period is being altered.
10. Keypad Lock Indicator - Displayed when the keypad is locked.
11. Units of Temperature - Degrees Celsius or Fahrenheit.
12. Clock - Digital clock display in 24h format.



## Setting the Clock (*Programmable Mode*)

To set the clock, follow these steps.

- With the thermostat turned ON, press the Clock key twice ..... 
- Use the Up/Down keys to set the hours ..... 
- Press H to confirm settings ..... 
- Use the Up/Down keys to set the minutes ..... 
- Press H to confirm settings ..... 
- Use the Up/Down keys to set the day of the week ..... 
- Press A to confirm settings and return to main display ..... 

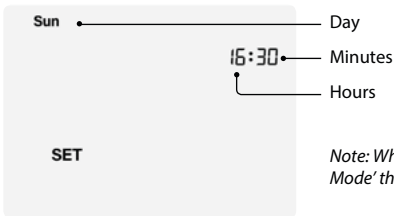

*Note: When 'Feature 11' is set to 'Manual Mode' the clock button does not respond.*



## Temperature Display

The temperature display information is driven by two different inputs; the sensor measurement and the target temperature you have set.

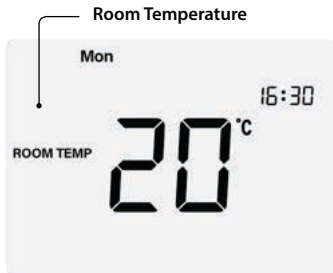

This is the current room temperature.

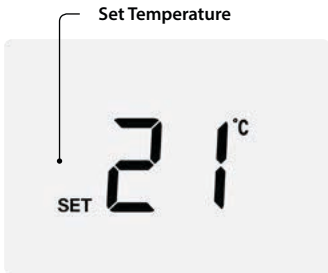

This is the temperature you are trying to achieve in your home.



# Comfort Levels Explained

(Programmable Mode)

The thermostat offers the following program mode options;

5/2 Day Programming – 4 levels for the weekdays and 4 different levels for the weekend.

7 Day Programming – 4 levels for each day.

24 hour Programming - 4 levels for all days.

*Consult the 'Optional Features' section to select the required mode.*

- To program comfort levels, press Clock once .....









*For Weekday/Weekend programming,  
Mon Tue Wed Thu Fri  
are displayed on screen.*



*For 7 Day programming,  
only Mon is displayed  
in the day indicator field.*

*For 24 hour programming, all days are displayed.*



- Use the Up/Down keys to enter the required WAKE time .....  
- Press H to confirm settings ..... 
- Use the Up/Down keys to enter the required WAKE temperature .....  
- Press H to confirm settings ..... 
- You will now see "LEAVE" displayed on screen.
- Repeat the programming steps for each period until complete.
- For unused periods enter --.-- and the thermostat will ignore the setting.
- Press A to confirm settings and return to main display ..... 

**Note:** In 7 Day programming mode you can repeat for each day independently. In Weekday/Weekend programming mode you will see Sat Sun displayed on screen and can repeat for the weekend. To change the programming mode please refer to pages 23-24.



## Locking the Thermostat

The thermostat has a keypad lock facility. To activate the lock follow these steps.

- Press and hold the A and Down keys together for 10 seconds ..... 
- You will see the lock symbol appear on screen ..... 
- To unlock, repeat the steps above until the lock symbol disappears.

*Note: The keypad lock indicator is only displayed when the lock is active.*

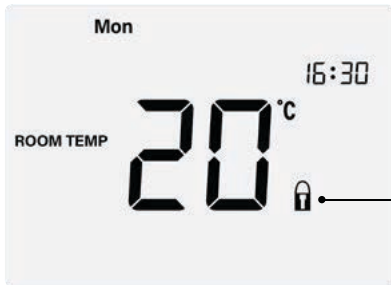

Keypad Lock Indicator





## Temperature Control

The Up/Down keys allow you to adjust the set temperature .....



When you press either key, you will see the word SET and the desired temperature will be displayed on screen.

Use the Up/Down keys to adjust the SET value .....



Press A to confirm settings and return to main display .....



*Note: In programmable mode, this new temperature is maintained only until the next programmed comfort level.*

*In non-programmable mode, this temperature will be constantly maintained.*

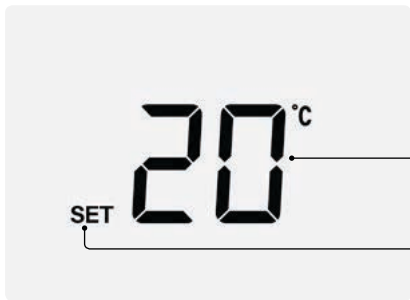

Set Temperature

Set Icon



## Temperature Hold

The temperature hold function allows you to manually override the current operating program and set a different temperature for a desired period.

- Press H to commence temperature hold .....
- Use the Up/Down keys to enter the required Hold time.....
- Press H to confirm settings .....
- Use the Up/Down keys to enter the required Hold temperature.....
- Press A to confirm settings and return to main display .....

You will see the 'Hold For' indication is displayed on screen.

The time will countdown the set duration and then revert to the normal program.



Hold For Indicator

Hold Time Remaining





To cancel temperature hold, follow the same steps but reduce the Hold time to 00:00 hours.



## Holiday

The holiday function reduces the set temperature in your home to the frost protection temperature setting (see page 19).

The thermostat will maintain this temperature for the duration of the holiday and will then automatically return to the program mode on your return.

- Press H three times (until you see the suitcase on screen) ..... 
- Use the Up/Down keys to enter the number of days holiday .....  
- Press A to confirm settings and return to main display ..... 

The display will show a suitcase indicating the thermostat is in holiday mode.

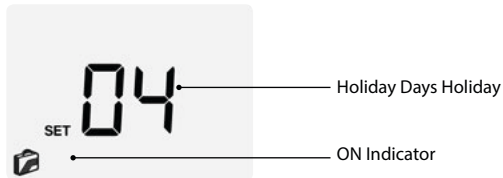

*Note: A holiday period does not start until 00:00 the next day. For example, if you set a holiday period on Friday for 2 days, Saturday will be counted as the first day and the thermostat will revert back to the programmed schedule at 00:00 on Monday.*



To cancel, follow the same steps but reduce the Holiday duration to 00 days.



## Frost Protection

Pressing the Power button  once will place the thermostat in frost protect mode. In this mode, the thermostat will display the frost icon and will only turn the heating on should the room temperature drop below the set frost temperature. Should the heating be turned on whilst in frost mode, the flame icon will be displayed. To cancel the frost protect mode, press the Power button once again. 

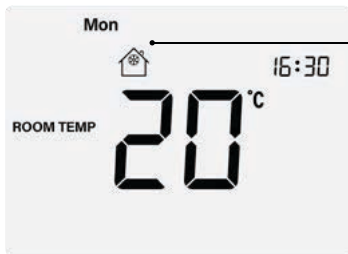

Frost Protection Mode Enabled

Frost set temperature range is from 7 to 17°C (12°C factory default)

*Note: If the display is turned off, the frost symbol will appear to represent heat demand in place of the flame symbol.*



## Heating On/Off

The heating is indicated ON when the flame icon is displayed.

When the flame icon is absent, there is no requirement for heating to achieve the set temperature but the thermostat remains active.

To turn the thermostat OFF completely, press and hold the Power button..... 

The display and heating output will be turned OFF completely.\*

To turn the thermostat back ON, press the Power button once again ..... 

Thermostat completely OFF



Thermostat powered ON



\*See Feature 3 on page 21



## Optional Features Explained

**THE FOLLOWING SETTINGS ARE OPTIONAL AND IN MOST CASES NEED NOT BE ADJUSTED**

**Feature 01 – Temperature Format:** This function allows you to select between °C and °F.

**Feature 02 – Switching Differential:** This function allows you to increase the switching differential of the thermostat. The default is 1°C which means that with a set temperature of 20°C, the thermostat will switch the heating on at 19°C and off at 20°C. With a 2°C differential, the heating will switch on at 18°C and off at 20°C.

**Feature 03 – Frost Protect:** You can set whether the thermostat will maintain the frost temperature when the thermostat display is turned off. As a default, this is enabled.

**Feature 04 – Output Delay:** To prevent rapid switching, an output delay can be entered. This can be set from 00 - 15 minutes. The default is 00 which means there is no delay.

**Feature 05 – Temperature Up/Down Limit:** This function allows you to limit the use of the up and down keys. This limit is also applicable when the thermostat is locked and so allows you to give others limited control over the heating system.

**Feature 06 – Sensor Selection:** On this thermostat you can select which sensor should be used. Built in sensor or remote air sensor.

**Feature 07 – Floor Temp Limit:** This function is not available on this model.

**Feature 08 – Optimum Start:** Optimum start will delay the start up of the heating system to the latest possible moment to avoid unnecessary heating and ensure the building is warm at the programmed time. The thermostat uses the rate of change information to calculate how long the heating needs to raise the building temperature 1°C (with a rate of change of 20, the thermostat has calculated the heating needs 20 minutes to raise the building temperature 1°C) and starts the heating accordingly.

**Feature 09 – Rate Of Change:** This is the number of minutes the thermostat has calculated it takes to raise your building temperature 1°C. The thermostat will continue to monitor and learn the heat up time of your home to optimise heating efficiency.

**Feature 10 – Programming Mode:** The following program modes are available;  
5/2 Day Programming – 4 levels for the weekdays and 4 different levels for the weekend.

7 Day Programming – 4 levels for each day.



24 Hours – 4 levels over a 24-hour period.

**Feature 11 – Thermostat Mode:** Here you can set in which mode you would like the thermostat to operate. The options are, manual (non-programmable) or programmable (Comfort Levels).





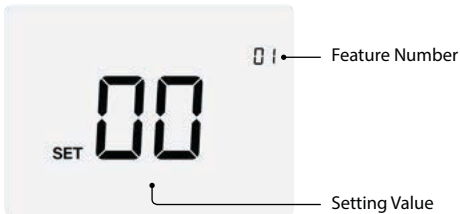

## Adjusting the Optional Features

To adjust the optional settings, follow these steps.

- Press and hold the Power button to turn the thermostat OFF ..... 
- Press and hold the Clock key until the display appears as shown below ..... 



- Use the Clock key to cycle through the features ..... 
- Use the Up/Down keys to change the setting ..... 
- Press A to confirm settings ..... 
- Press the Power button once again to turn the thermostat back ON ..... 





# Optional Features - Table





## Thermostat

| FEATURE | DESCRIPTION               | SETTING  |
|---------|---------------------------|--|
| 01      | Temperature Format        | 00 = °C, 01 = °F (°C = Default)  |
| 02      | Switching Differential    | 01° - 03°C (01°C = Default)  |
| 03      | Frost Mode                | 00 = Enabled, 01 = Disabled (00 = Default)   |
| 04      | Output Delay              | 00 - 15 Minutes (00 = Default)   |
| 05      | Up/Down Temperature Limit | 00° 10°C (00 = Default)  |
| 06      | Sensor Selection          | 00 = Built in Air Sensor<br>01 = Remote Air Sensor                                   |
| 07      | Floor Temperature Limit   | Not used on this model   |
| 08      | Optimum Start             | 00 - 03 Hours (00 = Default)   |
| 09      | Rate of Change            | Minutes to raise by 1°C  |
| 10      | Program Mode              | 00 = 5/2 Day Programming (Default)<br>01 = 7 Day Programming<br>02 = 24h Programming |
| 11      | Thermostat Mode           | 00 = Manual, 01 = Programmable (01 = Default)  |



## Re-calibrating the Thermostat

If you need to re-calibrate the thermostat, follow these steps.

- Press and hold the Power button to turn the thermostat OFF ..... 
- Press and hold BOTH the Power and Down keys together until the temperature appears on the screen ..... 
- Use the Up/Down keys to configure the new temperature ..... 
- Press A to confirm settings ..... 
- Press the Power button once to turn the thermostat back ON ..... 

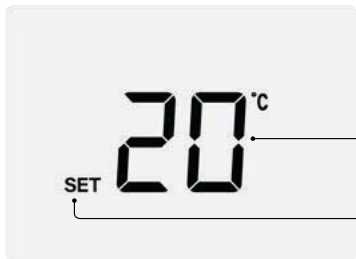

Calibration Temperature Setting

Set Icon



## Error Codes

**E0** = The internal sensor has developed a fault.  
You should contact your thermostat retailer for assistance.

**E2** = The remote air probe has not been connected, has been wired incorrectly or the probe is faulty.

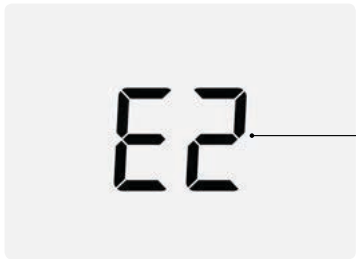

Error Number

# 2

## Mode 2 - Time Clock



The time clock can be used to control various devices in and around your home e.g. 'Hot Water', 'Towel Rails' or even 'Lighting'.

Refer to the manufacturers instructions for wiring to these devices.

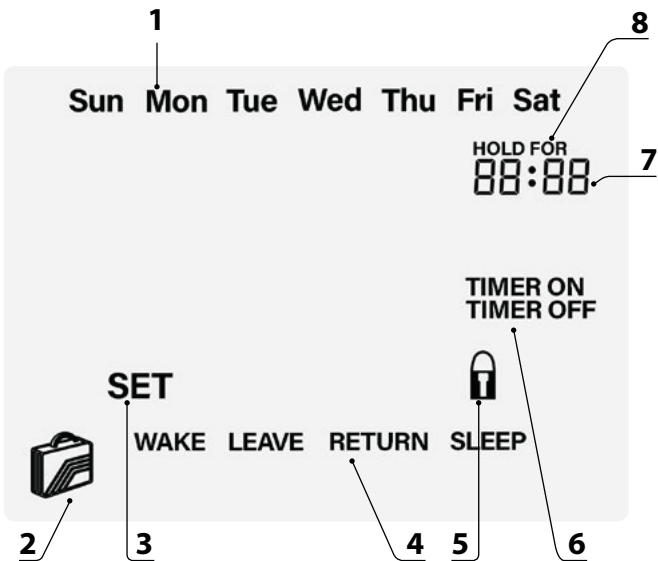









1. Day Indicator - Displays the current day.
2. Holiday Indicator - Displayed when the time clock is in holiday mode.
3. Set - Indicates when changes are being made to programs or clock settings.
4. Program Cycle Indicators - Displayed during programming only to show which period is being altered.
5. Keypad Lock Indicator - Displayed when the keypad is locked.
6. Timer Status – Displays the current status of the timed output.
7. Clock - Digital clock display in 24h format.
8. Hold For - Displayed when a timer override is active, the remaining time will be shown.



## Setting the Clock

To set the clock, follow these steps.

- In Countdown mode, press the Clock button once ..... 
- In either 5/2, 7-day, or 24h mode, press the Clock button twice ..... 
- Use the Up/Down buttons to set the hours..... 
- Press H to confirm settings ..... 
- Use the Up/Down buttons to set the minutes..... 
- Press H to confirm settings ..... 
- Use the Up/Down buttons to set the day of the week ..... 
- Press A to confirm settings and return to the main display ..... 

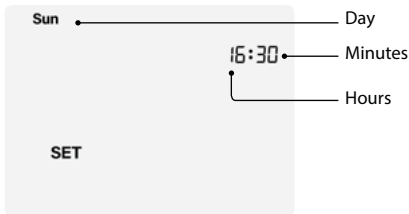



## Locking the Time Clock

This time clock has a keypad lock facility. To activate the lock follow these steps.

- Press and hold the A and Down keys together for 10 seconds .....
- You will see the lock symbol appear on screen .....
- To unlock, repeat the steps above until the lock symbol disappears.



*Note: The keypad lock indicator is only displayed when the lock is active.*

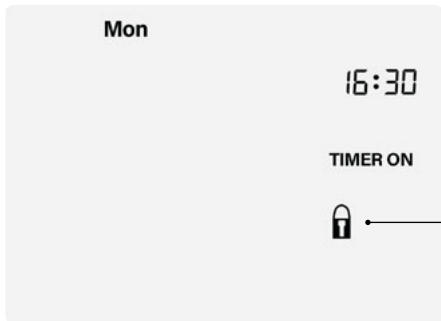







Keypad Lock Indicator







## Setting the Switching Times

To program the switching times, follow these steps.

- Press the Clock button once ..... 
- You will see Mon (7 day mode), Mon - Fri (5/2 day mode) or Mon -Sun (24H mode) displayed on screen. Use the Up/Down buttons to select the TIMER ON for the WAKE switching period ..... 
- Press H to confirm settings..... 
- Use the Up/Down buttons to select the TIMER OFF for the WAKE switching period ..... 
- Press H to confirm settings..... 
- Repeat these steps for LEAVE, RETURN and SLEEP levels.
- For unused periods set the time to -- : -- and the time clock will ignore the setting.
- If set to 5/2-day mode you'll now see Sat Sun displayed on screen. Repeat steps above for the weekend settings.
- Press A to confirm settings and return to main display..... 



## Countdown Mode

- Use the Up/Down buttons to set the countdown duration .....  
- Press A to confirm settings ..... 
- Hold For will appear showing the time left.

When Hold For is displayed on screen, the output will be active.

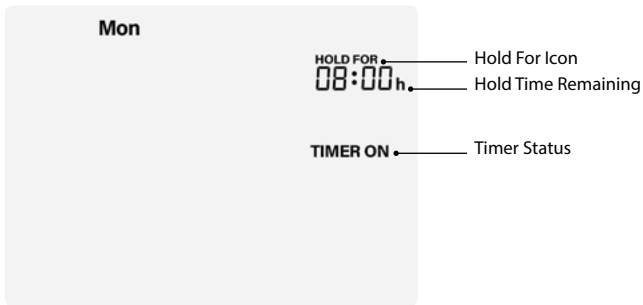

To cancel a countdown period, reduce time to 00:00.



## Timer Override

The time clock is able to override its current timer status.

If current status = Timer ON, – pressing A will switch it to Timer OFF ..... **A**

(TIMER OFF will flash to inform you the programmed output has been overridden)

The time clock will return to the program at the next programmed time.







## Holiday

The holiday function allows you to quickly enter a holiday setting.

During a holiday, the time clock will maintain TIMER OFF.

At the end of your holiday, the time clock will revert back to the programmed setting.

- Press H once (you will see the suitcase displayed on screen)..... 
- Use the Up/Down buttons to enter the number of days holiday ..... 
- Press A to confirm settings..... 

The display will show a suitcase indicating the time clock is in holiday mode.

*Note: A holiday period does not start until 00:00 the next day. For example, if you set a holiday period on Friday for 2 days, Saturday will be counted as the first day and the time clock will revert back to the programmed schedule at 00:00 on Monday.*

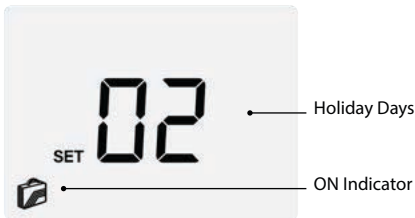

To cancel, follow the same steps but reduce the holiday duration to 00 days.



## Optional Features Explained

THE FOLLOWING SETTINGS ARE OPTIONAL AND IN MOST CASES NEED NOT BE ADJUSTED

**Feature 01 – Programming Mode:** The following program modes are available; 5/2 Day Programming – 4 levels for the weekdays and 4 different levels for the weekend.

7 Day Programming – 4 levels for each day.

24 Hours – 4 levels over a 24-hour period.

**Feature 02 - Time Clock Mode:** Here you can set in which mode you would like the time clock to operate. The options are, Countdown Timer or Programmable (Switching Times).



## Optional Features - Table

### Time Clock

| FEATURE | DESCRIPTION      | SETTING   |
|---------|------------------|---|
| 01      | Programming Mode | 00 = 5/2day (default), 01 = 7day, 02 = 24 hours |
| 02      | Time Clock Mode  | 00 = Countdown, 01 = Programmable (Default)     |



## Adjusting the Optional Settings

To adjust the optional settings, follow these steps.

- Press and hold the Power button to turn the time clock OFF.....
- Press and hold the Clock key until the display appears as shown below.....

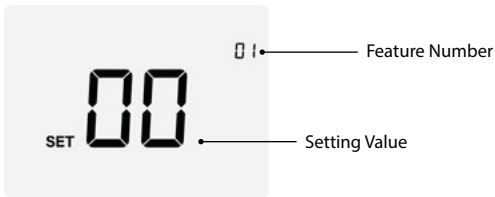

- Use the Clock key to cycle through the features .....
- Use the Up/Down keys to change the setting.....
- Press A to confirm settings .....
- Press the Power button once again to turn the time clock back ON .....





## Wiring Diagram - Slimline to Boiler 230v

**THIS UNIT MUST BE PROTECTED BY A FUSE OR RCD**

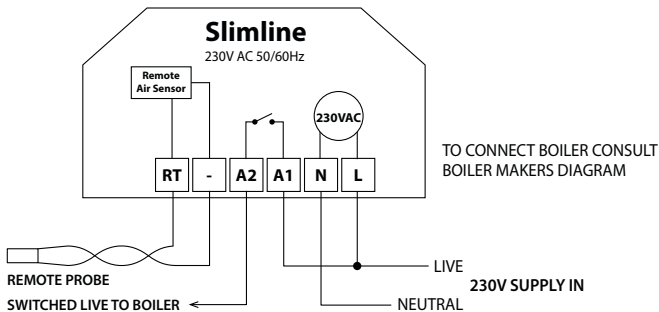

This product must only be installed by a qualified electrician and comply with local installation regulations.



## Wiring Diagram - Slimline to Boiler Volfree

**THIS UNIT MUST BE PROTECTED BY A FUSE OR RCD**

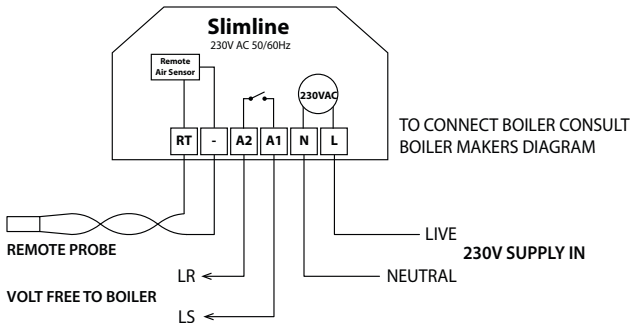

LS & LR ARE NORMALLY THE ROOM THERMOSTAT CONNECTIONS

This product must only be installed by a qualified electrician and comply with local installation regulations.





## Wiring Diagram - Slimline to Spring Return Valve

**THIS UNIT MUST BE PROTECTED BY A FUSE OR RCD**

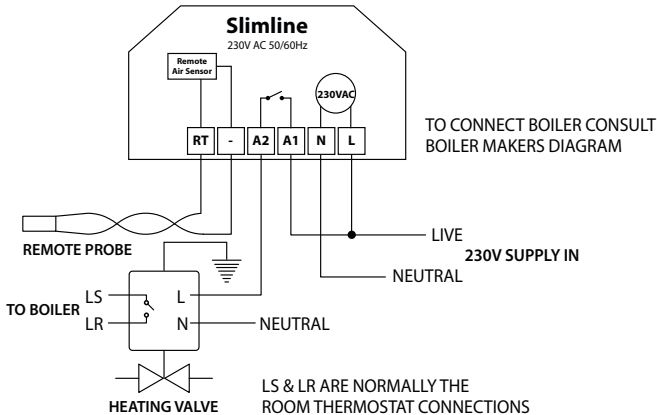

This product must only be installed by a qualified electrician and comply with local installation regulations.



## Notes

The time clock can be used to control various devices in and around your home e.g. lighting or towel rails.

Refer to the manufacturers instructions for wiring to these devices.

.....

.....

.....

.....

.....

.....

.....

.....

.....

.....

.....

.....



## Notes

A series of 18 horizontal dotted lines for taking notes.



## Want More Information?

Call our support team on: +44 (0)1254 669090

Or view technical specifications directly on our website:  
[www.heatmiser.com](http://www.heatmiser.com)



PDF



FAQ



VIDEO



Twitter: @heatmiseruk



Facebook: facebook.com/thermostats