

heatmiser®



Model: **PRT-TS WiFi**

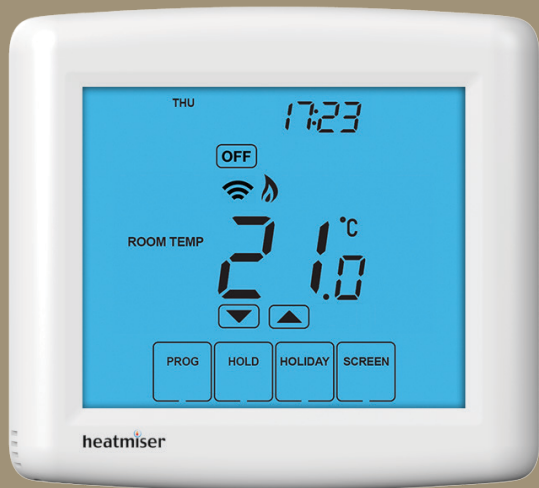

Table Of Contents

Product Image	1	Frost Protection	16
Table of Contents	2	Heating ON/OFF	16
What is a Programmable Room Thermostat?	3-4	Comfort Levels Explained	17-18
Installation Procedure	5-6	Clean Screen	19
LCD Display	7-8	Locking the Keypad	19
WiFi Setup	9-11	Temperature Control	20
Security Types and Compatibility	11-12	Temperature Hold	21
Remote Access Via Web App	13	Holiday Programming	22
Remote Access Via Web Browser	13	Optional Features	23-26
Setting the Clock	14	Re-calibrating the Thermostat	27
Temperature Display	15	Factory Reset	27
		Wiring Diagrams	28-30

? What is a Programmable Room Thermostat?

A programmable room thermostat is both a programmer and a room thermostat.

The programmer allows you to set “On” and “Off” periods to suit your own lifestyle. The room thermostat works by sensing the air temperature, switching on the heating when the air temperature falls below the thermostat setting, and switching it off once this set temperature has been reached.

So a programmable room thermostat lets you choose what times you want the heating to be on, and what temperature it should reach while it is on. It will allow you to select different temperatures in your home at different times of the day (and days of the week) to meet your particular needs and preferences.

Setting a room thermostat to a higher temperature will not make the room heat up any faster. How quickly the room heats up depends on the design & size of the heating system.

Similarly reducing the temperature setting does not affect how quickly the room cools down. Setting a programmable room thermostat to a lower temperature will result in the room being controlled at a lower temperature, and saves energy.

The way to set and use your programmable room thermostat is to find the lowest temperature settings that you are comfortable with at the different times you have chosen, and then leave it alone to do its job.

The best way to do this is to set the room thermostat to a low temperature – say 18°C, and then turn it up by 1°C each day until you are comfortable with the temperature. You won't have to adjust the thermostat further. Any adjustment above this setting will waste energy and cost you more money.

If your heating system is a boiler with radiators, there will usually be only one programmable room thermostat to control the whole house. But you can have different temperatures in individual rooms by installing thermostatic radiator valves (TRVs) on individual radiators.

If you don't have TRVs, you should choose a temperature that is reasonable for the whole house. If you do have TRVs, you can choose a slightly higher setting to make sure that even the coldest room is comfortable, then prevent any overheating in other rooms by adjusting the TRVs.

You are able to temporarily adjust the heating program by overriding or using the temperature hold feature. These features are explained further on pages 20 and 21 of this manual.

Programmable room thermostats need a free flow of air to sense the temperature, so they must not be covered by curtains or blocked by furniture. Nearby electric fires, televisions, wall or table lamps may also prevent the thermostat from working properly.



Installation Procedure



Do
Mount the thermostat at eye level.
Read the instructions fully so you get the best from our product.



Don't
Do not install near to a direct heat source as this will affect functionality.
Do not push hard on the LCD screen as this may cause irreparable damage.

This WiFi Series thermostat is designed to be flush mounted and requires a back box of 35mm (minimum depth) to be sunk into the wall prior to installation.

Step 1

Carefully separate the front half of the thermostat from the back plate by placing a small flat head terminal driver into the slots on the bottom face of the thermostat.

Step 2

Place the thermostat front somewhere safe.
Terminate the thermostat as shown in the diagrams on pages 28-30 of this booklet.

Step 3

Screw the thermostat back plate securely into the back box.

Step 4

Clip the front of the thermostat back onto the thermostat back plate.

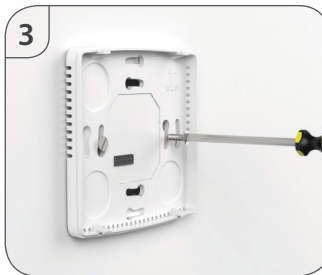
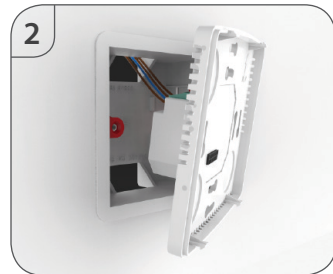

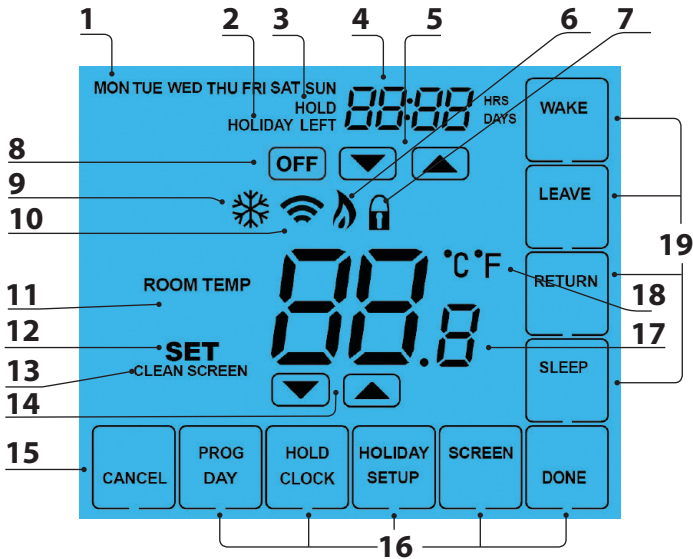

LCD

LCD Display

1. Day Indicator - Displays the day.
2. Holiday Indicator - Displayed when the programmer is in Holiday mode.
3. Temperature Hold - Displayed when the programmer is in Hold mode.
4. Clock - Displays time in normal operation, time left in hold or days left in holiday mode.
5. Up/Down Keys - Increase or decrease values shown on top digit group.
6. Flame Icon - Displayed when the heating is ON and flashes when the Optimum Start function is in operation.
7. Keypad Lock Icon - Displayed when the keypad is locked.
8. OFF Key - Single press to enable/disable frost protection mode, press and hold to turn the display off.
9. Frost Icon - Displayed when the thermostat is in frost protection mode.
10. WiFi Icon - Displayed when a WiFi connection is established.
11. Room Temp - Indicates current temperature sensor mode.
12. Set - Indicates when changes are being made to programs or temperature set points.
13. Clean Screen - Freezes screen temporarily to enable cleaning.
14. Up/Down Keys - Increase or decrease values shown on bottom digit group.
15. Cancel - Used to exit setup/program operations.
16. Setup/Programming Keys - Used to navigate setup options.
17. Current Temp - Indicates the current sensor temperature.
18. Units of Temperature - Degrees Celsius or Fahrenheit.
19. Comfort Level Selection Keys - Used in comfort level setup (see page 17).



Setting Up Your WiFi Thermostat

Step 1:

Download and install the WiFi thermostat setup utility from our web site:
www.heatmiser.co.uk/wifi

Step 2:

Connect the thermostat to your PC with the USB cable provided. This will power the thermostat through the USB port and will allow you to test the WiFi connection. Open the setup utility and press Read to view the current thermostat configuration.

Step 3:

Enter the SSID, Security Type and Security Code of your wireless network. These settings can usually be found on the underside of your wireless router. For more information please consult your router manual. See page 11 for additional information on security types and compatibility.

Step 4:

Enter a fixed IP address for your WiFi thermostat outside of the router DHCP range. It is likely that your network will be configured to operate on a DHCP basis. This means your router automatically issues an IP address to a device that successfully connects to the network.

Your WiFi thermostat needs a fixed IP address in order for local and remote access to operate and you must set this up manually.

Log into your wireless router and navigate to the LAN settings page.

Find and select the DHCP setup details.

This should define the IP range that can be assigned to devices connecting to the network.

As an example, you may have an IP starting range 192.168.1.1 and ending 192.168.1.99. This means you can safely provide your WiFi thermostat the IP address 192.168.1.100 as no other devices will be assigned this address by the router.

If your DHCP range is from 192.168.1.1 to 192.168.1.253 you cannot use 254 or above.

You need to change the DHCP range, taking care not to change any of the first 3 numbers.

***Tip!** When setting up an IP address, the first three sets of numbers must be the same as the router IP address and the fourth set must not be used elsewhere on the network.*

Step 5:

Enter the Subnet mask for the network. This information can usually be found on the underside of your wireless router.

Step 6:

Enter the IP address of your gateway and DNS. In most cases, this is the IP address of your wireless router.

If you have a multi-zone system and are using the Multi-Link, the Gateway of the thermostat will need to be configured as the IP address of the Multi-Link.

Step 7:

Create a unique username and password that will be used to access your thermostat from a web browser.

Default Username: admin

Default Password: admin

Change these settings to your personal preference and record for future use.

A 4 digit access PIN is required to use the smartphone/tablet app and also helps to secure your system.

Step 8:

When you have entered the details of your WiFi network press Apply and disconnect the USB cable, (the thermostat LCD should go blank).

Reconnect the USB cable to the WiFi thermostat, when the thermostat has rebooted it will attempt to connect to your network. This process takes approximately one minute and is complete when the WiFi symbol is displayed on screen.



Security Types and Compatibility

The WiFi Thermostats operate on the 802.11b standard.

If your router is a G model, you must ensure it is setup to work in B&G mode.

You will not be able to connect to your thermostat without changing this setting on G model routers.

There are currently 4 common methods of securing your wireless connection:

OPEN/DISABLED (not recommended)

W.P.A. (medium security)

W.E.P. (lowest security level)

W.P.A.2. (highest security)

Your choice of security settings in the thermostat must match the setting in your router. Often you will find WPA and WPA2 are a single option in the router. This is perfectly normal as the router automatically selects the correct security level and you can set the thermostat up using either one of these settings.

Passwords can be up to 63 characters in length including spaces _ . / \ characters. The W.E.P. option is not so simple. Some routers generate a hidden password from a pass phrase whilst others require a 10 or 26 digit hex password and won't accept anything else. Your thermostat utility can deal with both options but the following restrictions may apply:

A hex password can only be made up of the numbers 0 to 9 and the letters a to f (lower case only).

Hex passwords can only be 10 characters or 26 characters in length.

If a passphrase is used it must be either 5 or 13 characters in length but can be any letter or number.

Your thermostat will automatically calculate the same hidden password your router creates from the same phrase.

These restrictions are common to most routers but you should refer to the router manual for specific restrictions that apply to your model.



Remote Access via App

To remotely connect to your WiFi Thermostat you must forward a port within your router to your WiFi Thermostat.

As all routers are setup differently, you should consult your user manual or the manufacturer's website for more information.

Generally you should create a new service within your router. Within this service you must open **TCP port 8068**.

Use the port forwarding function to forward the new service to the IP address of your WiFi thermostat.



Remote Access via Web Browser

To remotely access your WiFi Thermostat via a web browser you must first open port 80 and forward this to the IP address of your WiFi Thermostat.

To connect to your thermostat, open your preferred browser and enter the IP address that you gave the thermostat during setup and press enter.

You will be asked to enter a password and username. These are both set to "admin" as default.











We recommend you change these settings to ensure the security of your system.

For further information, click the help link within the browser.



Setting the Clock

To set the clock, follow these steps.

- Press PROG and then CLOCK  
- Use the Down key to set the hours 
- Use the Up key to set the minutes 
- Press the CLOCK key 
- Use the Down key to set the day 
- Use the Up key to set the month 
- Press the CLOCK key 
- Use the Up/Down keys to set the year  
- Press DONE to confirm and exit 

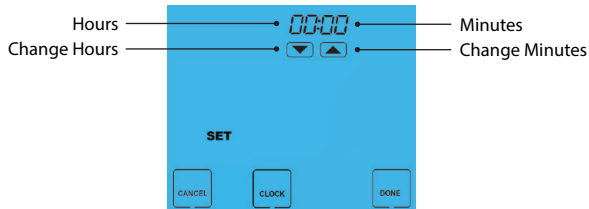

Temperature Display

The temperature display information is driven by two different inputs; the sensor measurement and the target temperature you have set.

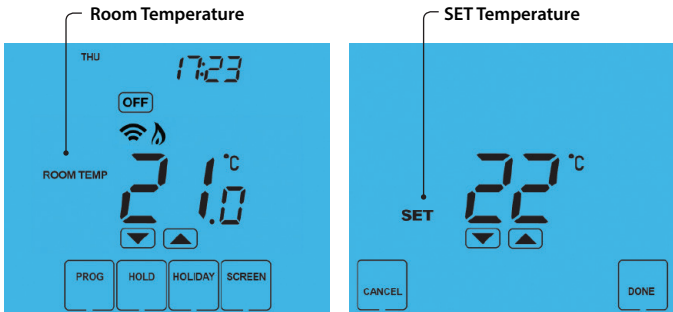

This is the current room temperature.

This is the temperature you are trying to achieve in your home.

Frost Mode

Pressing the **OFF** key once will place the thermostat in frost protect mode.

In this mode, the thermostat will display the frost icon and will only turn the heating on should the room temperature drop below the set frost temperature (see page 23).

Should the heating be turned on whilst in frost mode, the flame symbol will be displayed.

To cancel the frost protect mode, press the **OFF** key once.

Heating On/Off

The heating is indicated ON when the flame icon is displayed.

When the flame icon is absent, there is no requirement for heating to achieve the set temperature but the thermostat remains active.

To turn the thermostat OFF completely, press and hold the OFF key **OFF**

The display and heating output will be turned off completely.*

To turn the thermostat back ON, press the ON key **ON**

**See Feature 3 on page 23*



Comfort Levels Explained

Comfort levels allow you to set different temperatures throughout the day. For example, you may want the home warm in the morning when you are getting ready for work, cooler during the day when the house is unoccupied and then warmer in the evening when you are home relaxing.

The thermostat offers 2 programming options:

5/2 Day Programming - 4 levels for the weekdays and 4 different levels for the weekend.

7 Day Programming - 4 levels for each day.

See page 25 for details on how to switch between these modes.

Tip! If you don't want to use all of the comfort levels, just set the time to --:--

Default comfort levels are pre-programmed but you can change them easily.

Weekday Level	Time	Temp
Wake	08:00	21°C
Leave	09:30	16°C
Return	16:30	22°C
Sleep	23:00	17°C
Weekend Level	Time	Temp
Wake	09:00	21°C
Leave	22:00	16°C
Return	--:--	--°C
Sleep	--:--	--°C

- Press PROG
- Select WAKE
- Use the Up/Down keys to set the time for WAKE period
- Use the Up/Down keys to set the temperature
- Repeat these steps for the LEAVE, RETURN & SLEEP periods
- Press DAY to select the next day to program and repeat

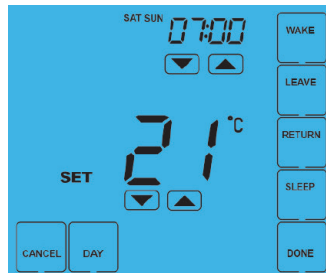

In 5/2 Day mode the thermostat will display "Sat Sun" prompting you to program the temperature levels for the weekend.

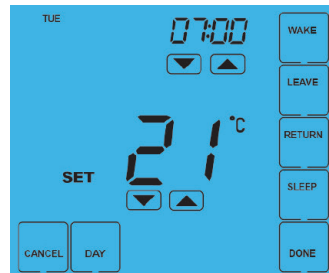

In 7 Day mode, the thermostat will display Tue.

- When complete, press DONE to confirm settings and exit

Clean Screen

Pressing  will disable all keys, providing you 15 seconds to wipe the screen clean before the keys are re-activated.



Locking the Keypad

The thermostat has a keypad lock facility.

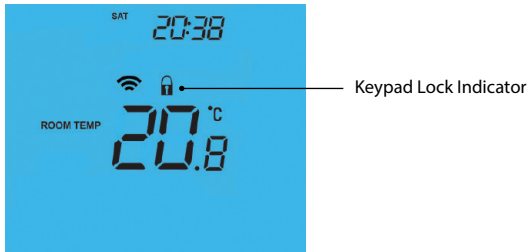
- To activate the lock press the bottom right corner of the display and hold for 10 secs.
- When activated, you will see the Keypad Lock symbol. 
- To cancel, press the bottom right corner of the display again for 10 secs.



Temperature Control

The   keys under the temperature display allow you to adjust the set temperature.

When you press either of these keys, you will see the temperature and the word SET appear on screen.

Select the desired temperature and press  to confirm and exit.



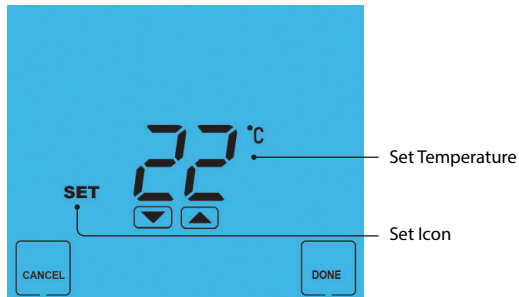

Note: This new temperature is maintained only until the next programmed comfort level. At this time, the thermostat will revert back to the programmed levels.





Temperature Hold

The temperature hold function allows you to manually override the current operating program and set a different temperature for a desired period.

- Press HOLD 
- Use the top set of Up/Down keys set the hold period 
- Use the center set of Up/Down keys to set the hold temperature 
- Press DONE to confirm and exit 

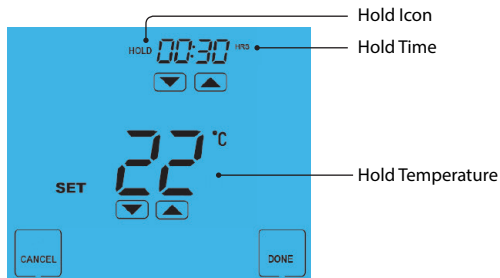



To cancel a temperature hold, follow the same steps but reduce the time to 00:00.



Holiday

The holiday function reduces the set temperature in your home to the frost protection temperature setting (see page 23).

The thermostat will maintain this temperature for the duration of the holiday and will then automatically return to the program mode on your return.

- Press HOLIDAY 
- Enter the desired duration in days 
- Press Done 

Note: A holiday period does not start until 00:00 the next day. For example, if you set a holiday period on Friday for 2 days, Saturday will be counted as the first day and the thermostat will revert back to the programmed schedule at 00:00 on Monday.

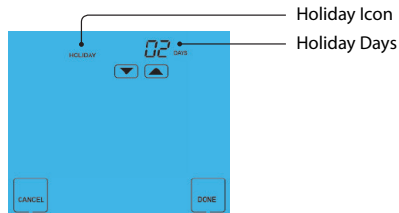

To cancel a Holiday setting, reduce the holiday time to 00 days.



Optional Features Explained

THE FOLLOWING SETTINGS ARE OPTIONAL AND IN MOST CASES NEED NOT BE ADJUSTED

Feature 01 – Temperature Format: This function allows you to select between °C or °F.

Feature 02 - Switching Differential: This function allows you to increase the switching differential of the thermostat. The default is 1°C which means the thermostat will switch the heating on 1°C below the set temperature and will turn it off when the set temperature is achieved. With a 2°C differential, the heating will switch on 2°C below the set temperature and will switch off when the set temperature is achieved.

Feature 03 - Frost Protect: You can set whether the thermostat will maintain the frost temperature when the thermostat display is turned off. As a default, this is enabled.

Feature 04 – Frost Protect Temperature: This is the temperature maintained when the thermostat is in frost mode. The range is 07-17°C. The default is 12°C and is suitable for most applications.

Feature 05 – Output Delay: To prevent rapid switching, an output delay can be entered. This can be set from 00 - 15 minutes. The default is 00 which means there is no delay.

Feature 06 – Not used on this model.

Feature 07 – Temperature Up/Down Limit: This function allows you to limit the use of the up and down keys. This limit is also applicable when the thermostat is locked and so allows you to give others limited control over the heating system.

Feature 08 – Air Sensor Selection: This thermostat uses the internal sensor and cannot be adjusted.

Feature 09 – Floor Limit Sensor: This function is not adjustable on this model.

Feature 10 – Optimum Start: Optimum start will delay the start up of the heating system to the latest possible moment to avoid unnecessary heating and ensure the building is warm at the programmed time. The thermostat uses the rate of change information to calculate how long the heating needs to raise the building temperature 1°C (with a rate of change of 20, the thermostat has calculated the building needs 20 minutes to raise the building temperature 1°C) and starts the heating accordingly.

Feature 11 – Rate Of Change: This is the number of minutes the thermostat has calculated it takes to raise your building temperature 1°C. The thermostat will continue to monitor and learn the heat up time of your home to optimise heating efficiency.

Feature 12 - Programming Mode: The thermostat offers 2 programming methods. Weekday/Weekend allows you to program 4 comfort levels for the weekdays and 4 different comfort levels for the weekend. In 7 Day program mode, each day has 4 comfort levels that can be programmed independently.





Adjusting the Optional Settings

To adjust the optional settings, follow these steps.

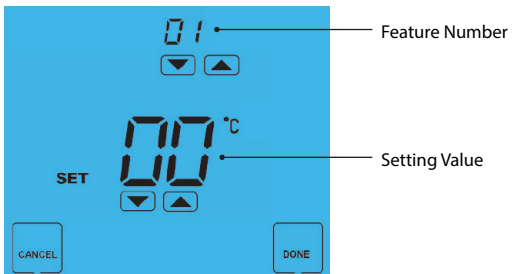
- Press PROG 
- Press SETUP 



- Use the Up/Down keys at the top of the screen to select the feature number (shown on page 26) and then use the Up/Down keys in the center to adjust the setting 
- Press DONE to confirm settings and exit 



Optional Settings - Feature Table

FEATURE	DESCRIPTION	SETTING
01	Temperature Format	00 = °C, 01 = °F (°C = Default)
02	Switching Differential	0.5° - 3.0°C (1.0°C = Default)
03	Frost Protect	00 = Disabled, 01 = Enabled (01 = Default)
04	Frost Protection Temperature	07° - 17°C (12°C = Default)
05	Output Delay	Enter Value: 00 - 15 Minutes (00 = Default)
06	Communications ID No.	Not available on this model
07	Up/Down Temperature Limit	00° - 10°C (00 = Default)
08	Sensor Selection	Fixed on Internal Sensor
09	Floor Temperature Limit	Not available on this model
10	Optimum Start (Pre-Heat)	00 = Disabled (Default) 01 = 01hr, 02 = 02hr, 03 = 03hr
11	Rate of Change	For Information Only
12	Program Mode	00 = Weekday/Weekend (Default) 01 = 7 Day Programming



Re-calibrating the Thermostat

If you need to re-calibrate the thermostat, follow these steps.

- Press and hold the OFF key to turn the thermostat OFF
- Press and hold the ON key until the temperature appears on the screen
- Use the Up/Down keys to configure the new temperature
- Press DONE to confirm the new temperature
- Press the ON key once to turn the thermostat back ON



Factory Reset

The thermostat has a reset function to restore all settings to their factory defaults.

To perform a factory reset, follow these steps.

- Press & hold the OFF key to turn the thermostat display OFF
- Press and hold the bottom left corner of the LCD for 10 seconds.
- All of the screen icons will appear for 2 seconds and then disappear.
- Press the ON key once to turn the thermostat display back ON



Wiring Diagram - PRT-TS WiFi Switched Live to Boiler

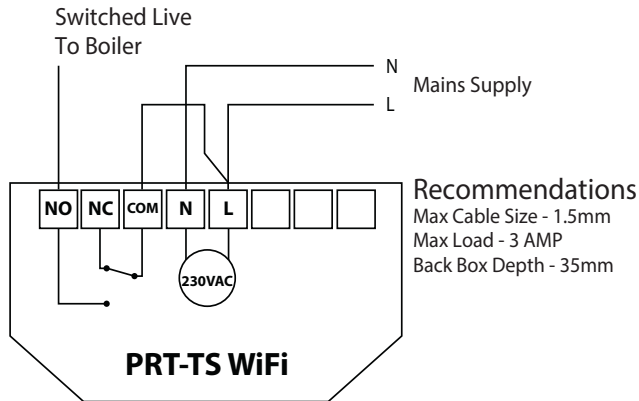

Recommendations
 Max Cable Size - 1.5mm
 Max Load - 3 AMP
 Back Box Depth - 35mm



Wiring Diagram - PRT-TS WiFi Voltfree to Boiler

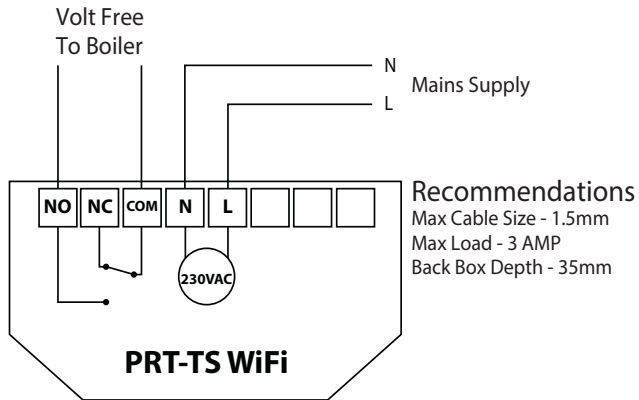

Wiring Diagram - PRT-TS WiFi with Heating Valve

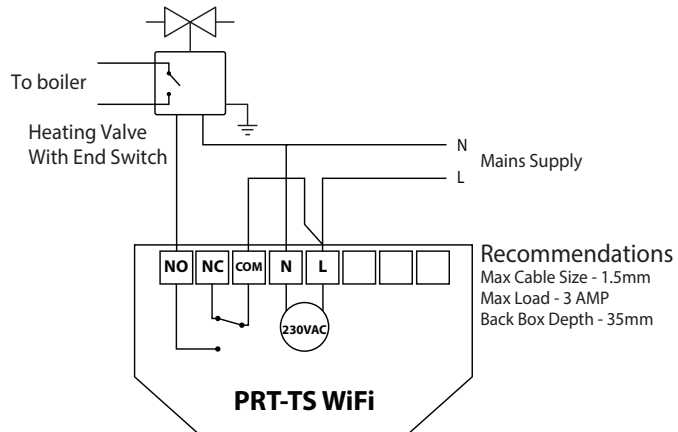



Heating Professionals:
Request a copy of our product installation guide containing detailed technical specifications for our complete product range:
www.heatmiser.com/guide

Want More Information?

Call our support team on: +44 (0)1254 669090

Or view technical specifications directly on our website:
www.heatmiser.com



PDF



FAQ



Twitter: [heatmiseruk](https://twitter.com/heatmiseruk)



Facebook: facebook.com/thermostats