

heatmiser®



Model: Touch-N

## Model: Touch-N





# Table Of Contents

Product Image	1	Temperature Hold	15
Table of Contents	2	Holiday Programming	16
What is a Programmable Room Thermostat?	3-4	Frost Protection	17
Installation Procedure	5-6	Heating ON/OFF	18
LCD Display	7-8	Optional Features Explained	19-21
Setting the Clock	9	Adjusting the Optional Settings	22
Temperature Display	10	Optional Settings - Features Table	23
Comfort Levels Explained	11-12	Error Codes	24
Clean Screen	13	Re-calibrating the Thermostat	25
Locking the Keypad	13	Factory Reset	26
Temperature Control	14	Wiring Diagrams	27-28

## What is a Programmable Room Thermostat?

A programmable room thermostat is both a programmer and a room thermostat.

The programmer allows you to set “On” and “Off” periods to suit your own lifestyle. The room thermostat works by sensing the air temperature, switching on the heating when the air temperature falls below the thermostat setting, and switching it off once this set temperature has been reached.

So a programmable room thermostat lets you choose what times you want the heating to be on, and what temperature it should reach while it is on. It will allow you to select different temperatures in your home at different times of the day (and days of the week) to meet your particular needs and preferences.

Setting a room thermostat to a higher temperature will not make the room heat up any faster. How quickly the room heats up depends on the design & size of the heating system.

Similarly reducing the temperature setting does not affect how quickly the room cools down. Setting a programmable room thermostat to a lower temperature will result in the room being controlled at a lower temperature, and saves energy.

The way to set and use your programmable room thermostat is to find the lowest temperature settings that you are comfortable with at the different times you have chosen, and then leave it alone to do its job.

The best way to do this is to set the room thermostat to a low temperature – say 18°C , and then turn it up by 1°C each day until you are comfortable with the temperature. You won't have to adjust the thermostat further. Any adjustment above this setting will waste energy and cost you more money.

If your heating system is a boiler with radiators, there will usually be only one programmable room thermostat to control the whole house. But you can have different temperatures in individual rooms by installing thermostatic radiator valves (TRVs) on individual radiators.

If you don't have TRVs, you should choose a temperature that is reasonable for the whole house. If you do have TRVs, you can choose a slightly higher setting to make sure that even the coldest room is comfortable, then prevent any overheating in other rooms by adjusting the TRVs.

You are able to temporarily adjust the heating program by overriding or using the temperature hold feature. These features are explained further on pages 14 and 15 of this manual.

Programmable room thermostats need a free flow of air to sense the temperature, so they must not be covered by curtains or blocked by furniture. Nearby electric fires, televisions, wall or table lamps may also prevent the thermostat from working properly.



## Installation Procedure



### Do

Mount the thermostat at eye level.

Read the instructions fully so you get the best from our product.



### Don't

Do not install near to a direct heat source as this will affect functionality.

Do not push hard on the LCD screen as this may cause irreparable damage.

*This Touch Series thermostat is designed to be flush mounted and requires a back box of 35mm (minimum depth) to be sunk into the wall prior to installation.*

### Step 1

Carefully separate the front half of the thermostat from the back plate by placing a small flat head terminal driver into the slots on the bottom face of the thermostat.

### Step 2

Place the thermostat front somewhere safe.

Terminate the thermostat as shown in the diagrams on pages 27-28 of this booklet.

### Step 3

Screw the thermostat back plate securely into the back box.

### Step 4

Clip the front of the thermostat back onto the thermostat back plate.

1



2



3



4



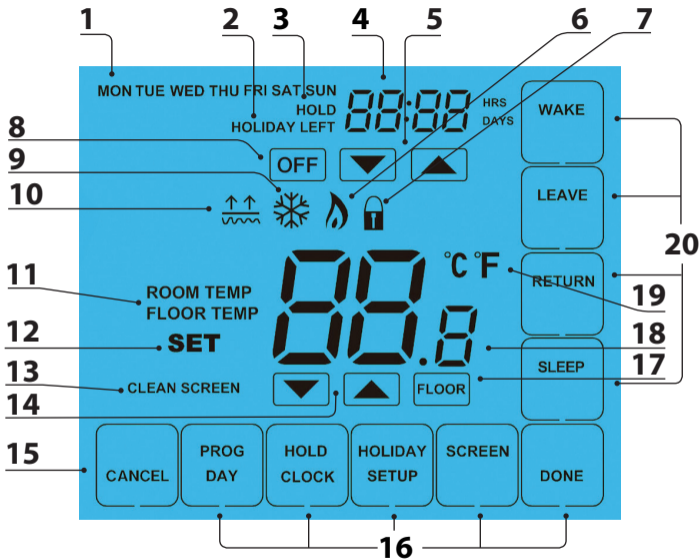



1. Day Indicator - Displays the day of the week.
2. Holiday Indicator - Displayed when the thermostat is in Holiday mode.
3. Temperature Hold - Displayed when the thermostat is in Hold mode.
4. Clock - Displays time in normal operation, time left in hold or days left in holiday mode.
5. Up/Down Keys - Increase or decrease values shown on top digit group.
6. Flame Icon - Displayed when the thermostat is calling for heat, the flame icon will flash when optimum start function is in operation.
7. Keypad Lock Icon - Displayed when the keypad is locked.
8. OFF Key - Single press to enable/disable frost protection or press and hold to turn off display.
9. Frost Icon - Displayed when the thermostat is in frost protection mode.
10. Floor Temp Achieved Icon - Displayed when the floor set point temperature is reached.
11. Room/Floor Temp - Indicates the current temperature sensor mode.
12. Set - Indicates when changes are being made to programs or temperature set points.
13. Clean Screen - Freezes screen temporarily to enable cleaning.
14. Up/Down Keys - Increase or decrease values shown on bottom digit group.
15. Cancel Key - Used to exit setup/program operations.
16. Setup/Programming Keys - Used to navigate setup options.
17. View Floor Temperature Key - Used to change display to show floor temperature.
18. Current Temp - Indicates the current sensor temperature.
19. Units of Temperature - Degrees Celsius or Fahrenheit.
20. Comfort Level Selection Keys - Used in comfort level setup (see page 11).



# Setting the Clock

To set the clock, follow these steps.

- Press PROG .....
- Press CLOCK .....
- Use the Down key to set the hours .....
- Use the Up key to set the minutes .....
- Use the Day key to set the day of the week .....
- Press DONE to confirm and exit .....

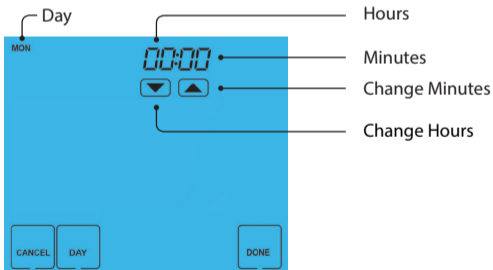

## Temperature Display

The temperature display information is driven by two different inputs; the sensor measurement and the target temperature you have set.



This is the current room/floor temperature.

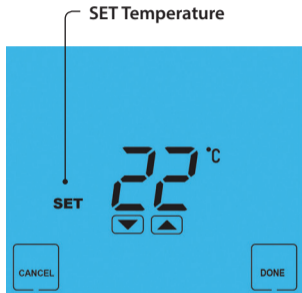

This is the temperature you are trying to achieve in your home.

When the thermostat is in air and floor sensing mode, the thermostat will display a FLOOR button.

Pressing this allows you to view the current floor temperature.

Pressing FLOOR again will return the thermostat to the room temperature display.



## Comfort Levels Explained

Comfort levels allow you to set different temperatures throughout the day. For example, you may want the home warm in the morning when you are getting ready for work, cooler during the day when the house is unoccupied and then warmer in the evening when you are home relaxing.

The thermostat offers 2 programming options:

5/2 Day Programming - 4 levels for the weekdays and 4 different levels for the weekend.

7 Day Programming - 4 levels for each day.

*See page 21 for details on how to switch between these modes.*

**Tip!** If you don't want to use all of the comfort levels, just set the time to --:--

Default comfort levels are pre-programmed but you can change them easily.

### **Weekday Level**

	<b>Time</b>	<b>Temp</b>
Wake	08:00	21°C
Leave	09:30	16°C
Return	16:30	22°C
Sleep	23:00	17°C

### **Weekend Level**

	<b>Time</b>	<b>Temp</b>
Wake	09:00	21°C
Leave	22:00	16°C
Return	--:--	--°C
Sleep	--:--	--°C

- Press PROG .....
- Select WAKE .....
- Use the Up/Down keys to set the time for WAKE period .....
- Use the Up/Down keys to set the temperature .....
- Repeat these steps for the LEAVE, RETURN & SLEEP periods .....
- Press DAY to select the next day to program and repeat .....

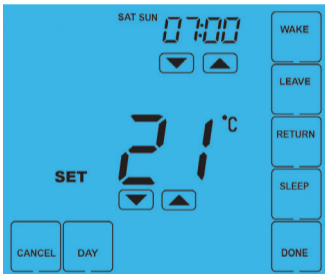

*In 5/2 Day mode the thermostat will display "Sat Sun" prompting you to program the temperature levels for the weekend.*

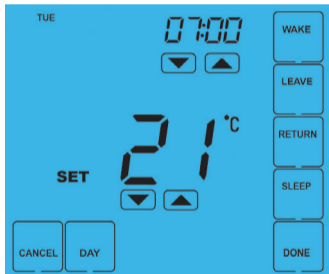

*In 7 Day mode, the thermostat will display Tue.*

- When complete, press DONE to confirm settings and exit .....





## Clean Screen

Pressing **SCREEN** will disable all keys, providing you 15 seconds to wipe the screen clean before the keys are re-activated.



## Locking the Keypad

The thermostat has a keypad lock facility.



- To activate the lock press the bottom right corner of the display and hold for 10 secs.
- When activated, you will see the Keypad Lock symbol. 
- To cancel, press the bottom right corner of the display again for 10 secs.



Keypad Lock Indicator



## Temperature Control

The   keys under the temperature display allow you to adjust the set temperature.

When you press either of these keys, you will see the temperature and the word SET appear on screen.

Select the desired temperature and press  to confirm and exit.



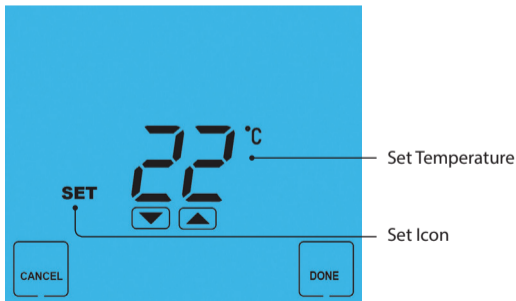

*Note: This new temperature is maintained only until the next programmed comfort level. At this time, the thermostat will revert back to the programmed levels.*





## Temperature Hold

The temperature Hold function allows you to manually override the current operating program and set a different temperature for a desired period.

- Press HOLD ..... 
- Use the top set of Up/Down keys to set the hold period ..... 
- Use the center set of Up/Down keys to set the hold temperature ..... 
- Press DONE to confirm and exit ..... 

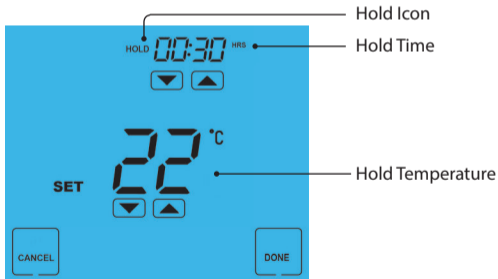

To cancel a Temperature Hold, follow the same steps but reduce the time to 00:00.





## Holiday

The Holiday function reduces the set temperature in your home to the frost protection temperature setting (see page 19).

The thermostat will maintain this temperature for the duration of the holiday and will then automatically return to the program mode on your return.

- Press HOLIDAY .....
- Enter the desired duration in days .....
- Press DONE to confirm and exit .....

HOLIDAY



DONE

*Note: A holiday period does not start until 00:00 the next day. For example, if you set a holiday period on Friday for 2 days, Saturday will be counted as the first day and the thermostat will revert back to the programmed schedule at 00:00 on Monday.*

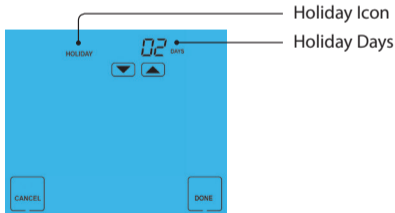

To cancel a Holiday setting, reduce the Holiday time to 00 days.



## Frost Mode

Pressing the **OFF** key once will place the thermostat in frost protect mode.

In this mode, the thermostat will display the frost icon and will only turn the heating on should the room temperature drop below the set frost temperature (see page 19).

Should the heating be turned on whilst in frost mode, the flame symbol will be displayed.

To cancel the frost protect mode, press the **OFF** key once.

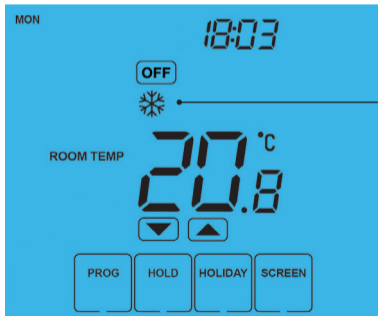

Frost Protection Mode Enabled



## Heating On/Off

The heating is indicated ON when the flame icon is displayed.

When the flame icon is absent, there is no requirement for heating to achieve the set temperature but the thermostat remains active.

To turn the thermostat OFF completely, press and hold the OFF key .....

The display and heating output will be turned off completely.\*

To turn the thermostat back ON, press the ON key once .....

Thermostat completely OFF



Thermostat powered ON



\*See Feature 3 on page 19



## Optional Features Explained

THE FOLLOWING SETTINGS ARE OPTIONAL AND IN MOST CASES NEED NOT BE ADJUSTED

**Feature 01 – Temperature Format:** This function allows you to select between °C or °F.

**Feature 02 - Switching Differential:** This function allows you to increase the switching differential of the thermostat. The default is 1°C which means the thermostat will switch the heating on 1°C below the set temperature and will turn it off when the set temperature is achieved. With a 2°C differential, the heating will switch on 2°C below the set temperature and will switch off when the set temperature is achieved.

**Feature 03 - Frost Protect:** You can set whether the thermostat will maintain the frost temperature when the thermostat display is turned off. As a default, this is enabled.

**Feature 04 – Frost Protect Temperature:** This is the temperature maintained when the thermostat is in frost mode. The range is 07-17°C. The default is 12°C and is suitable for most applications.

**Feature 05 – Output Delay:** To prevent rapid switching, an output delay can be entered. This can be set from 00 -15 minutes. The default is 00 which means there is no delay.

**Feature 06 – Communication Address:** This setting is used when you have connected your thermostat to a network system. Each thermostat on the network must have a unique communication address. This can be set from 01-32.

**Feature 07 – Temperature Up/Down Limit:** This function allows you to limit the use of the up and down keys. This limit is also applicable when the thermostat is locked and so allows you to give others limited control over the heating system.

**Feature 08 – Sensor Selection:** This thermostat offers 5 sensor modes.

**00 = Built in air sensor.** In this mode, the thermostat will maintain the set temperature by monitoring the built in air sensor.

*Note: Built in air sensor only MUST NOT be used to control electric under-floor heating. Floor sensor only or built in air & floor sensor together must be used.*

**01 = Remote air sensor.** In this mode, the thermostat will maintain the set temperature by monitoring the remote air sensor.

**02 = Floor sensor.** In this mode, the thermostat will maintain the set temperature by monitoring the remote floor temperature.

**03 = Floor sensor and built in air sensor.** In this mode, the thermostat will maintain the set temperature by monitoring the built in air sensor and will also ensure the floor surface doesn't overheat by monitoring the remote floor sensor.

**04 = Floor sensor and remote air sensor.** In this mode, the thermostat will maintain the set temperature by monitoring the remote air sensor and will also ensure the floor surface doesn't overheat by monitoring the remote floor sensor.

**Feature 09 – Floor Limit Temperature:** This function allows you to set a maximum floor temperature in order to protect the floor surface from overheating. This function works for Sensor Modes 02, 03 & 04 (see above). The default setting is 27°C.



## Optional Features Continued

**Feature 10 – Optimum Start:** Optimum start will delay the start up of the heating system to the latest possible moment to avoid unnecessary heating and ensure the building is warm at the programmed time. The thermostat uses the rate of change information to calculate how long the heating needs to raise the building temperature 1°C (with a rate of change of 20, the thermostat has calculated the heating needs 20 minutes to raise the building temperature 1°C) and starts the heating accordingly.

**Feature 11 – Rate Of Change:** This is the number of minutes the thermostat has calculated it takes to raise your building temperature 1°C. The thermostat will continue to monitor and learn the heat up time of your home to optimise heating efficiency.

**Feature 12 - Programming Mode:** The thermostat offers 2 programming methods. Weekday/Weekend allows you to program 4 comfort levels for the weekdays and 4 different comfort levels for the weekend. In 7 Day program mode, each day has 4 comfort levels that can be programmed independently.



## Adjusting the Optional Settings

To adjust the optional settings, follow these steps.

- Press PROG .....
- Press SETUP .....

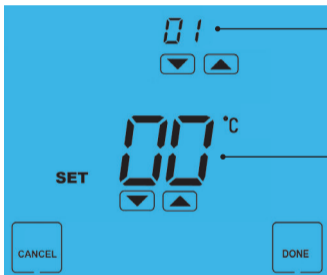

Feature Number

Setting Value

- Use the Up/Down keys at the top of the screen to select the feature number (shown on pages 19-21) and then use the Up/Down keys in the center to adjust the setting .....
- Press DONE to confirm settings and exit .....





## Optional Settings - Feature Table

FEATURE	DESCRIPTION	SETTING
01	Temperature Format	00 = °C, 01 = °F (°C = Default)
02	Switching Differential	0.5° - 3.0°C (1°C = Default)
03	Frost Protect	00 = Disabled, 01 = Enabled (01 = Default)
04	Frost Protection Temperature	07° - 17°C (12°C = Default)
05	Output Delay	Enter Value: 00 - 15 Minutes (00 = Default)
06	Communications ID No.	Enter number 01-32
07	Up/Down Temperature Limit	00° - 10°C (00 = Default)
08	Sensor Selection	00 = Built in Air Sensor 01 = Remote Air Sensor 02 = Floor Sensor 03 = Floor Sensor and Built in Air Sensor 04 = Floor Sensor and Remote Air Sensor
09	Floor Temperature Limit	20-45°C (27°C = Default)
10	Optimum Start	00 = Disabled (Default) 01 = 01hr, 02 = 02hr, 03 = 03hr
11	Rate of Change	For Information Only
12	Program Mode	00 = 5/2 Day Programming 01 = 7 Day Programming





## Error Codes

**E0** = The internal sensor has developed a fault.  
You should contact your thermostat retailer for assistance.

**E1** = The remote floor probe has not been connected, has been wired incorrectly or the probe is faulty.

**E2** = The remote air probe has not been connected, has been wired incorrectly or the probe is faulty.

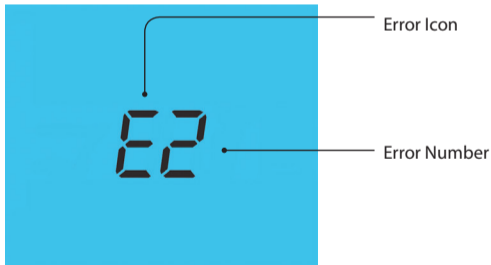



## Re-calibrating the Thermostat

If you need to re-calibrate the thermostat, follow these steps.

- Press and hold the OFF key to turn the thermostat OFF .....
- Press and hold the ON key until the temperature appears on the screen .....
- Use the Up/Down keys to configure the new temperature .....
- Press DONE to confirm the new temperature .....
- Press the ON key once to turn the thermostat back ON .....

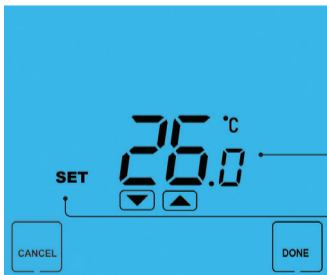

Calibration Temperature Setting

Set Icon



## Factory Reset

The thermostat has a reset function to restore all settings to their factory defaults.

To perform a factory reset, follow these steps.

- Press & hold the OFF key to turn the thermostat display OFF ..... **OFF**
- Press and hold the bottom left corner of the LCD for 10 seconds.
- All of the screen icons will appear for 2 seconds and then disappear.
- Press the ON key once to turn the thermostat display back ON ..... **ON**

All icons displayed simultaneously.

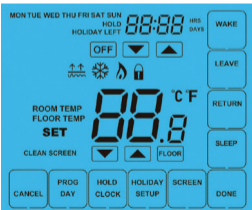

Factory reset is complete.

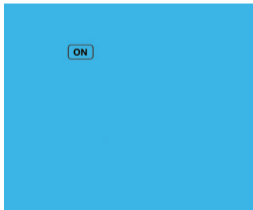



## Wiring Diagram – Touch-N to UH1

Remote sensors for use in wet area or where floor temperature control or limiting is required.

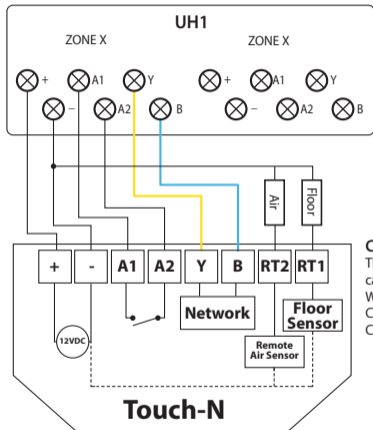

### Connecting Touch-N to the UH1

The UH1 is an 8 zone wiring centre that can be expanded to control up to 32 zones. When connecting Touch-N to the UH1 use CAT5-FTP or BELDEN 9538. Connect the screen to Earth at the UH1.



## Wiring Diagram – Touch-N to PRC

For 230V switched live output, link mains L to C

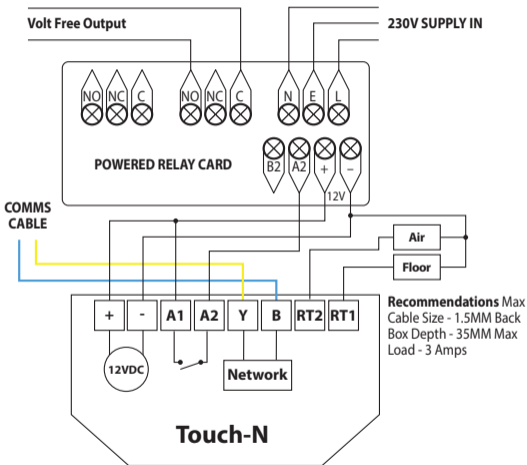



## Notes

A series of horizontal dotted lines for writing notes, spanning the width of the page.



## Notes

A series of 18 horizontal dotted lines for writing notes.



## Want More Information?

Call our support team on: +44 (0)1254 669090

Or view technical specifications directly on our website:  
[www.heatmiser.com](http://www.heatmiser.com)



PDF



FAQ



Twitter: @heatmiseruk



Facebook: facebook.com/thermostats